

Product:

PM fiber coupled AOM

TYPE:

SGTF200-1064-1P

Introduction:

Acousto-optic modulator is one of the optic-electricity devices based on acoustic-optic effect, modulating the optic signals or shifting frequency with electricity controlling by manufacturing acousto-optic devices.

**Key Features:**

- Fast modulation speed
- Low insertion loss
- High extinction ratio
- Small volume
- Good temperature stability and reliability

General Specifications:

Parameters	Unit	Min	Typical	Max	Remarks
Optical Material	TeO ₂				
Wavelength	nm	1030	1064	1080	-
IL	dB	1.5	2.5	3.0	-
ER	dB	45	-	-	-
PER	dB	18	22	-	-
Rise time	ns	8	10	12	-
Frequency shift	MHz	-	200	-	-
Driving power	W	0.8	1.2	1.5	-
Light tolerance	W	-	-	1	-
Peak light tolerance	kW	-	-	1	-
Fiber length	m	1	1.2	-	-
Fiber optic joint	FC/APC				
Fiber	PM980				
Package Specification	FA				
RF driver recommended	SGT200-02-N-1D				

Outline dimension:

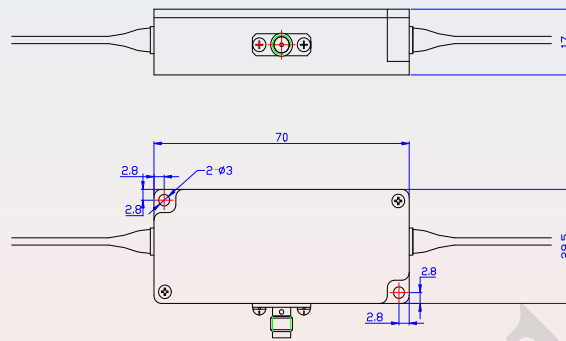

Package Specification: FA