

Product:

PM fiber coupled AOM

Type:

SGTF80-1550-1P

Introduction:

Acousto-optic modulator is one of the optic-electricity devices based on acoustic-optic effect, modulating the optic signals or shifting frequency with electricity controlling by manufacturing acousto-optic devices.

**Key Features:**

- Fast modulation speed
- Low insertion loss
- High extinction ratio
- Small volume
- Good temperature stability and reliability

General Specifications:

Parameters	Unit	Min	Typical	Max	Remarks
Optical Material	TeO ₂				
Wavelength	nm	1520	1550	1580	-
IL	dB	2.0	2.5	3.0	-
ER	dB	45	-	-	-
PER	dB	18	22	-	-
Rise time	ns	45	55	60	-
Frequency shift	MHz	-	80	-	-
Driving power	W	0.5	1	1.5	-
Light tolerance	W	-	-	1	-
Peak light tolerance	kW	-	-	1	-
Fiber length	m	1	1.2	-	-
Fiber optic joint	FC/APC				
Fiber	PM1550				
Package Specification	FA				
RF driver recommended	SGT80-02-N-1D				

Outline dimension:

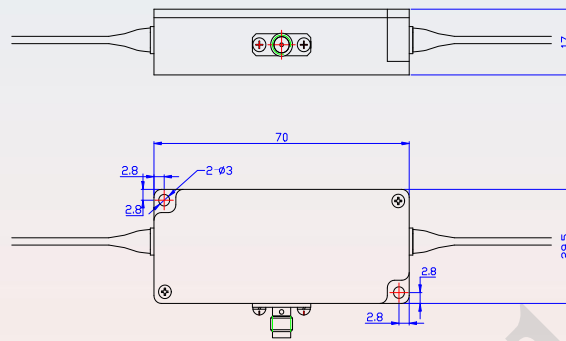

Package Specification: FA