

**405nm 450mW 14-Pin Butterfly Package Fiber Coupled Diode Laser With TEC | Violet Laser Diode**  
**400nm~405nm~410nm| 14-Pin BTF Package With 105um UV Fiber |Built-in TEC Cooling | Built-in PD**  
**WSLX-405-450m-M-H14-T-PD      Wavespectrum Laser Group      www.wavespectrum-laser.com**

PARAMETER	SYMBOL	VALUE	UNIT
Reverse Voltage	$V_r$	2.0	V
Operating Temperature	$T_{op}$	0 ~ +30	°C
Storage Temperature	$T_{stg}$	-40 ~ +85	°C
Lead soldering temperature (10 sec.)	$T_{is}$	260	°C

<b>Features:</b> <ul style="list-style-type: none"> <li> 405nm</li> <li> 450mW Output Power</li> <li> Built-in TEC Cooling</li> <li> Built-in Photodiode</li> <li> High Stability</li> </ul>	
<b>Applications:</b> <ul style="list-style-type: none"> <li> Medical Laser Treatment</li> <li> Others</li> </ul>	

Specifications	WSLX-405-450m-M-H14-T-PD		
	Min.	Type	Max.
Center Wavelength@25°C	405nm±10nm		
Spectral Width (FWHM)	----	2nm	----
Output Power	----	450mW	----
Recommended Operating Temperature	25 °C		
Threshold Current (Typ.)	----	120mA	200mA
Operating Current (Typ.)	----	420mA	450mA
Operating Voltage		4.5V	5.5V
TEC Max Current	2A		
TEC Max Voltage	8V		
Fiber Type	UV Multi-mode Fiber		
Fiber Core	105um		
Fiber Length	>80cm		
Connector Type	SMA905/FC		
Package	14-Pin		

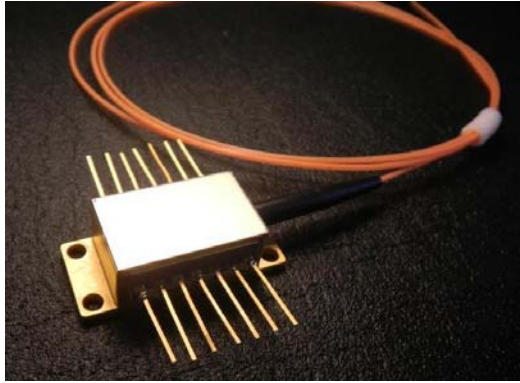

### 14-Pin Package View

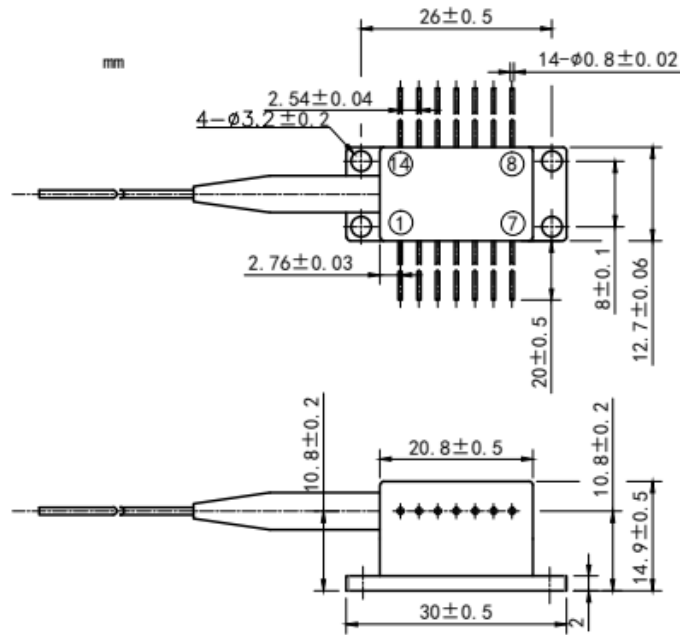

### Pin Out:

PIN	FUNCTION	PIN	FUNCTION
1	TEC(+)	14	TEC(-)
2	THERMISTOR	13	CASE
3	PD(+)	12	NC
4	PD(-)	11	LD(-)
5	THERMISTOR	10	LD(+)
6	NC	9	NC
7	NC	8	NC

Electrically shorten LD module and store in non-extreme conditions.

Suggest using the constant current power supply.

