

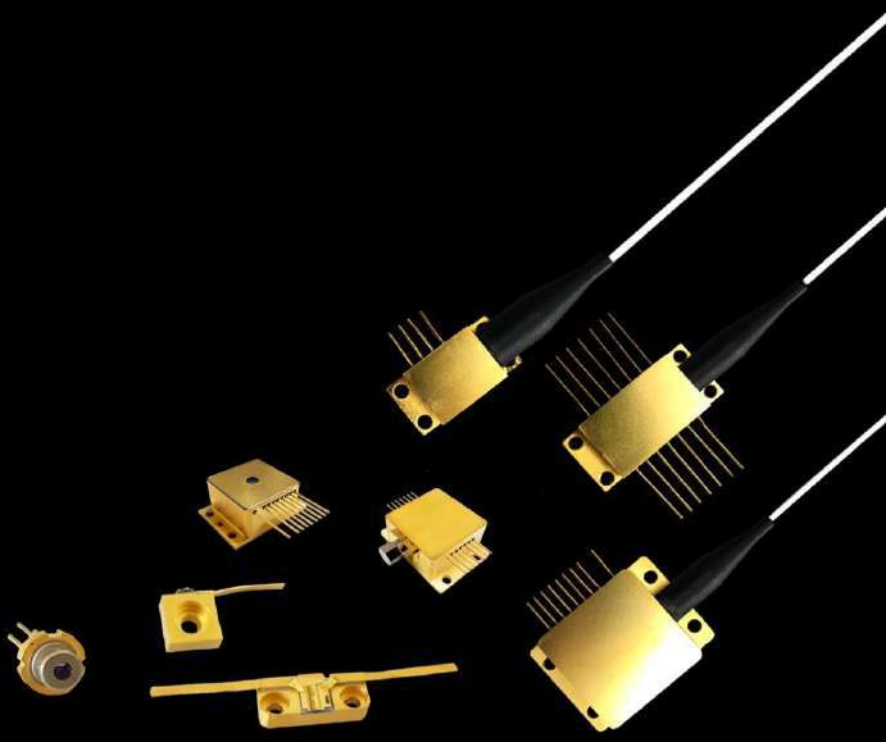

CATALOG

Multi-mode Fiber Coupled Laser Module



Product Portfolio

630nm 633nm
635nm 638nm
640nm 650nm
653nm 660nm
670nm 680nm
685nm 690nm

Red Laser

705nm
730nm 755nm 760nm
770nm 780nm 785nm
790nm 808nm 820nm
830nm 850nm 860nm
880nm 905nm 915nm
940nm 960nm 980nm
1064nm

IR Laser

505nm 510nm
520nm 525nm
532nm

Green Laser

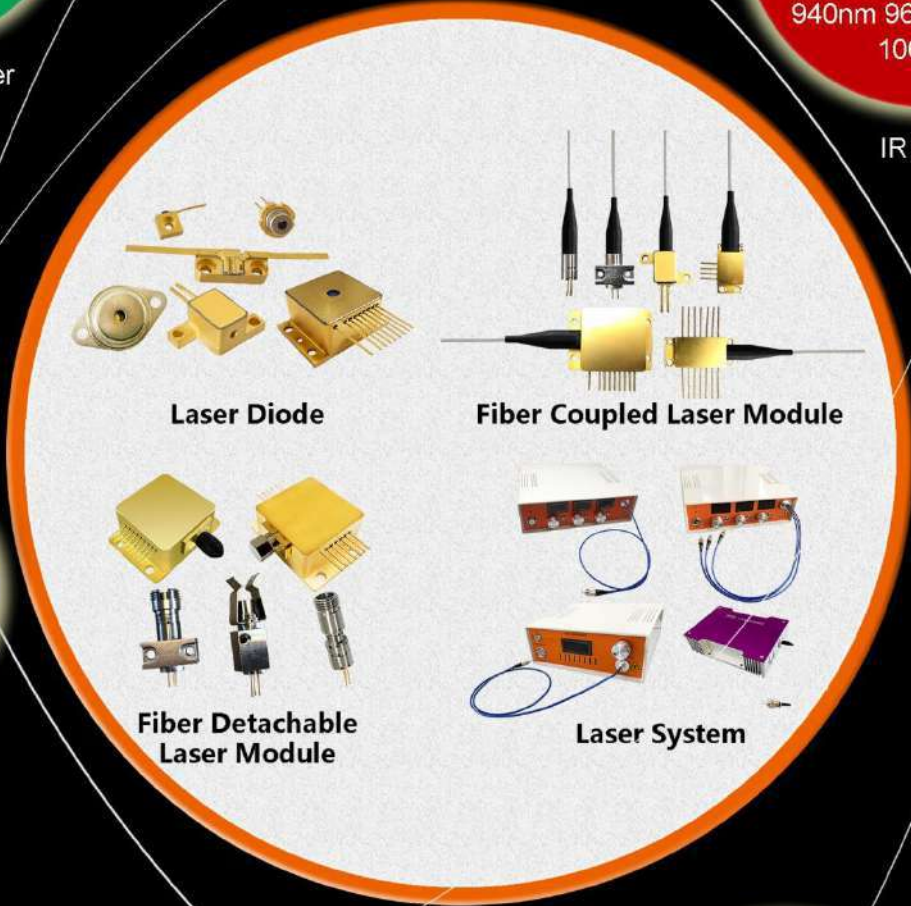

Laser Diode

Fiber Coupled Laser Module

Fiber Detachable Laser Module

Laser System

425nm
435nm 445nm
450nm 455nm
460nm 465nm
473nm 480nm
488nm 495nm

Blue Laser

375nm
395nm 400nm
405nm 410nm
413nm

UV Laser

1270nm
1290nm 1310nm
1330nm 1350nm 1370nm
1390nm 1410nm 1430nm
1450nm 1470nm 1490nm
1510nm 1530nm 1550nm
1570nm 1590nm 1610nm
1625nm 1650nm
1920nm

IR Laser



WAVESPECTRUM GROUP was founded in 1999. It is comprised by a group of experienced and innovative experts in the fields of laser physics, materials science, electronic technology and mechanical design. It has established solid cooperation with some famous universities, research institutes and laboratories.

Wavespectrum products are widely used in space science, optical communication technology, laser display, laser medical, life sciences and materials processing. With the rapid development, R&D centers and production bases have been established in China and Europe. The current plant area is 4,000 square meters, including 2,000 square meters of Class 1,000 clean workshops.

Wavespectrum products include laser diodes, fiber-coupled laser modules and fiber-coupled laser systems with wavelengths from 375nm to 1920nm. Our products are used in medical, printing, laser display, life science, laser communication and other fields. At present, the products have all passed the certifications of ROHS, REACH, CE, etc. At the same time, we have got ISO9001 quality management system certification.

Wavespectrum has world-class R&D team, and it has the world first-class production processing plants. Our products can meet the military-grade production and design standards. The products are well acclaimed world-wide, such in Germany, Austria, the United States, Japan, South Korea and other parts of the world. We have established close cooperation with a number of well-known enterprises world-wide.

Wavespectrum offers laser products with wavelength ranges from 375nm to 1920nm.

375nm	395nm	400nm	405nm	410nm	413nm	435nm	445nm	450nm	455nm	460nm	465nm	473nm
480nm	488nm	495nm	505nm	510nm	520nm	525nm	532nm	630nm	633nm	635nm	638nm	640nm
650nm	653nm	660nm	670nm	680nm	685nm	690nm	705nm	730nm	755nm	760nm	770nm	780nm
785nm	790nm	808nm	820nm	830nm	850nm	860nm	880nm	905nm	915nm	940nm	960nm	980nm
1064nm	1210nm	1270nm	1280nm	1290nm	1310nm	1330nm	1350nm	1370nm	1390nm	1410nm	1430nm	1450nm
1470nm	1490nm	1510nm	1530nm	1550nm	1570nm	1590nm	1610nm	1625nm	1650nm	1720nm	1900nm	1920nm

Pls visit our website for more detailed information: <http://en.wavespectrum-laser.com.cn>

CONTACT US

Wavespectrum Laser Group Limited

Address : 2-2-1504, 2# Haitai Innovation 6th Road, Xiqing Dist, 300392, TianJin, China

Web : www.wavespectrum-laser.com.cn

Email : sales@wavespectrum-laser.com.cn

Tel : +86-022-87931118

Fax : +86-022-86392109

Distributors Wanted World-Wide!



日本デバイス株式会社 E-mail sales@j-device.com

www.j-device.com

Tel 03-6262-3424 Fax 03-6800-5883

Product Catalogue

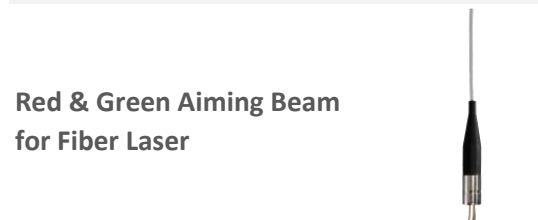
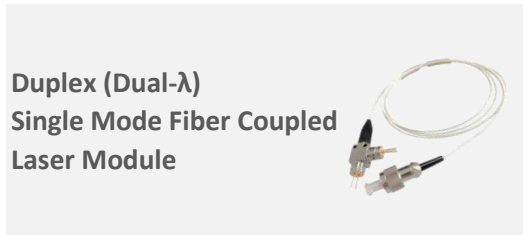
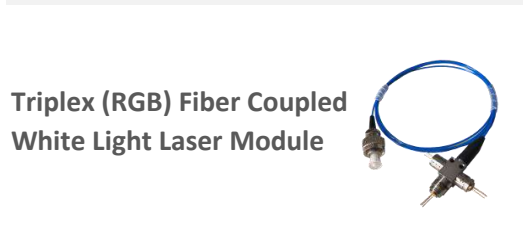
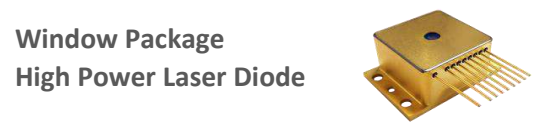
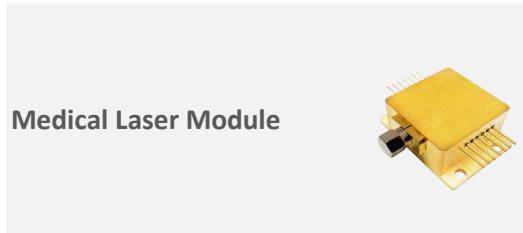
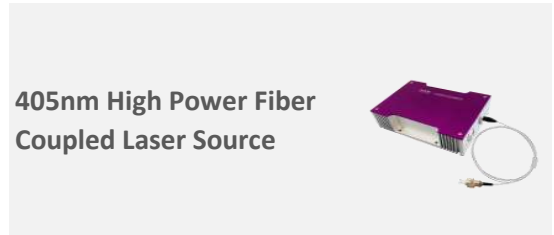
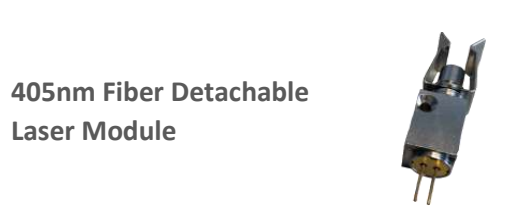
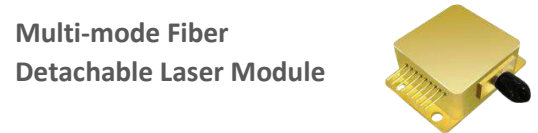
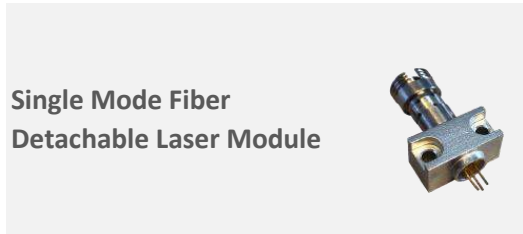
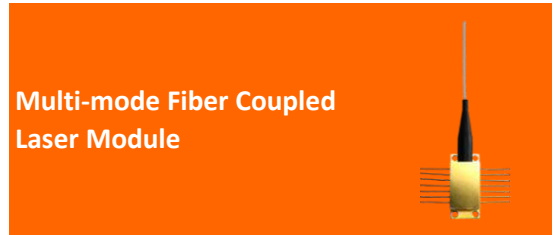
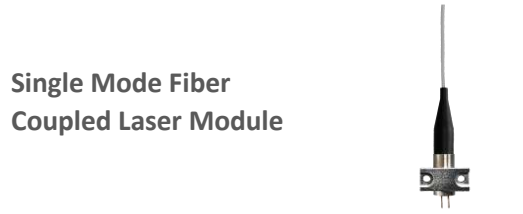
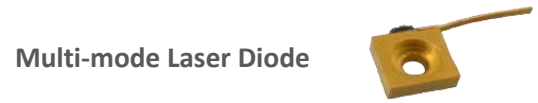
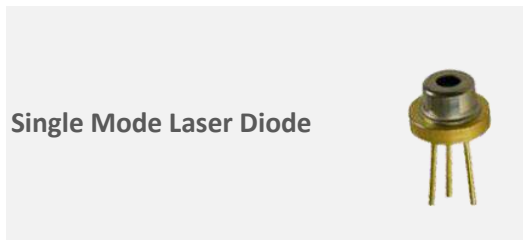

Product Catalogue

Turnkey Fiber Coupled
Diode Laser System



OEM Fiber Coupled
Diode Laser System



3-channel (Multi-channel)
Fiber Coupled Laser System



3-wavelength (Multi-λ)
Fiber Coupled Laser System



High Power Fiber
Bundled Laser Module



Multi-wavelength Fiber
Coupled Laser Module



Collimated Laser Diode



Photodiode



Multi-mode Fiber Coupled Laser Module

PRODUCT FEATURE

375nm~1920nm
 5mW~50W Output Power
 50um/ 105um/ 200um/ 400um Fiber Core
 Coaxial/ 2-PIN/ 4-PIN/ 14-PIN/ 9-PIN Package
 Built-in TE Cooler Optional
 Built-in Photodiode Optional
 Red/Green Aiming Beam Optional for IR LASER
 Long Lifetime
 High Stability
 Customized Wavelength
 Customized Output Power
 Customized Fiber Core

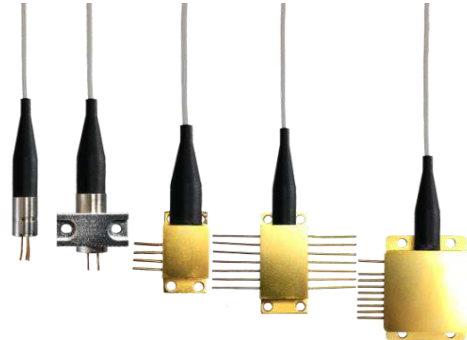

PRODUCT OVERVIEW

Multi-mode Fiber Coupled Laser Module is the competitive product of WAVESPECTRUM.

We offer High Coupling Efficient Solution for 375nm~1920nm Pigtailed Laser Module with 50um,105um,200um,400um Fiber Core, the output power ranges from 5mW to 50W. Meanwhile, the TE Cooler and Photodiode is optional for customers, the Green or Red Aiming Beam is also optional for IR Lasers. We can integrate these functions into the Laser Module as per customer's requirement. The standard package of the lasers can be Coaxial,2-PIN,4-PIN,14-PIN and 9-PIN.

WAVESPECTRUM also offer the Customized Solution for Pigtailed Laser Modules, such as Customized Wavelength, Customized Power, Customized Fiber Core and Customized Package to meet the special needs of customers.

WAVESPECTRUM use laser welding technology to guarantee the long-term reliability of the laser structure. To ensure the long-term reliability, each laser diode will undergo rigorous testing and aging in the factory. Meanwhile the high-low storage temperature circulation is also necessary for each laser diode. We set the storage temperature range from -40°C to +85°C, and it lasts 10 cycles, which will ensure the long-term reliability of the coupling structure.



Wavelength	Part Number	Output Power	Fiber Type	Fiber Core	Package	Connector	PD	TEC
375nm	WSLP-375-100m-M	100mW	MMF	UV 105um	Coaxial	FC/PC	×	✓
	WSLX-375-100m-M-H9-T	100mW	MMF	UV 105um	9-Pin	FC/PC	×	✓
395nm	WSLP-395-200m-50M	200mW	MMF	UV 50um	Coaxial	FC/PC	×	×
	WSLX-395-200m-50M-H-T	200mW	MMF	UV 50um	HHL-01	FC/PC	×	✓
	WSP-395-200m-M	200mW	MMF	UV 105um	Coaxial	FC/PC	×	×
	WSLX-395-200m-M-H-T	200mW	MMF	UV 105um	HHL-01	FC/PC	×	✓
	WSLX-395-200m-M-H14-T-PD	200mW	MMF	UV 105um	14-Pin	FC/PC	✓	✓
400nm	WSP-400-400m-M	400mW	MMF	UV 105um	Coaxial	FC/PC	×	×
	WSLX-400-400m-M-H14-T-PD	400mW	MMF	UV 105um	14-Pin	FC/PC	✓	✓
	WSLX-400-400m-M-H-T	400mW	MMF	UV 105um	HHL-01	FC/PC	×	✓
405nm	WSP-405-200m-50M	200mW	MMF	UV 50um	Coaxial	FC/PC	×	×
	WSLX-405-200m-50M-H-T	200mW	MMF	UV 50um	HHL-01	FC/PC	○	✓
	WSP-405-200m-M	200mW	MMF	UV 105um	Coaxial	FC/PC	×	×
	WSLX-405-200m-M-H-T	200mW	MMF	UV 105um	HHL-01	FC/PC	○	✓
	WSP-405-300m-M	300mW	MMF	UV 105um	Coaxial	FC/PC	×	×
	WSLX-405-300m-M-H-T	300mW	MMF	UV 105um	HHL-01	FC/PC	○	✓
	WSLX-405-300m-M-H14-T-PD	300mW	MMF	UV 105um	14-Pin	FC/PC	✓	✓
	WSP-405-400m-50M	400mW	MMF	UV 50um	Coaxial	FC/PC	×	×
	WSLX-405-400m-50M-H-T	400mW	MMF	UV 50um	HHL-01	FC/PC	○	✓
	WSLX-405-400m-50M-H14-T-PD	400mW	MMF	UV 50um	14-Pin	FC/PC	✓	✓
	WSP-405-450m-M	450mW	MMF	UV 105um	Coaxial	FC/PC	×	×
	WSLX-405-450m-M-H-T	450mW	MMF	UV 105um	HHL-01	FC/PC	○	✓
	WSLX-405-450m-M-H14-T-PD	450mW	MMF	UV 105um	14-Pin	FC/PC	✓	✓
	WSP-405-600m-M	600mW	MMF	UV 105um	Coaxial	FC/PC	×	×
	WSLX-405-600m-M-H14-T-PD	600mW	MMF	UV 105um	14-Pin	FC/PC	✓	✓
WSLX-405-002-M-H9-T	2W	MMF	UV 105um	9-Pin	FC/PC	×	✓	
410nm	WSP-410-300m-M	300mW	MMF	UV 105um	Coaxial	FC/PC	×	×
	WSLX-410-300m-M-H-T	300mW	MMF	UV 105um	HHL-01	FC/PC	×	✓
	WSLX-410-300m-M-H14-T-PD	300mW	MMF	UV 105um	14-Pin	FC/PC	✓	✓
413nm	WSP-413-300m-M	300mW	MMF	UV 105um	Coaxial	FC/PC	×	×
	WSLX-413-300m-M-H-T	300mW	MMF	UV 105um	HHL-01	FC/PC	×	✓
420nm	WSP-420-800m-M	800mW	MMF	UV 105um	Coaxial	FC/PC	×	×
	WSLX-420-800m-M-H14-T-PD	800mW	MMF	UV 105um	14-Pin	FC/PC	✓	✓
435nm	WSP-435-003-M	3W	MMF	105um	Coaxial	FC/PC	×	×
	WSLX-435-003-M-H9-T-PD	3W	MMF	105um	9-Pin	FC/PC	✓	✓
445nm	WSP-445-050m-M	50mW	MMF	105um	Coaxial	FC/PC	×	×
	WSLX-445-050m-M-H8-T	50mW	MMF	105um	8-Pin	FC/PC	○	✓
	WSP-445-080m-M	80mW	MMF	105um	Coaxial	FC/PC	×	×

Note: ✓:Yes, ○:Optional, ×:No.

Wavelength	Part Number	Output Power	Fiber Type	Fiber Core	Package	Connector	PD	TEC
445nm	WSLX-445-080m-M-H8-T	80mW	MMF	105um	8-Pin	FC/PC	○	√
	WSP-445-800m-M	800mW	MMF	105um	Coaxial	FC/PC	×	×
	WSP-445-001-M	1W	MMF	105um	Coaxial	FC/PC	×	×
	WSLX-445-001-M-H-T	1W	MMF	105um	HHL-01	FC/PC	○	√
	WSLX-445-001-M-H14-T-PD	1W	MMF	105um	14-Pin	FC/PC	√	√
	WSP-445-3500m-M	3.5W	MMF	105um	Coaxial	FC/PC	×	×
	WSLX-445-3500m-M-H9-T-PD	3.5W	MMF	105um	9-Pin	FC/PC	√	√
	WSLX-445-010-200M-H	10W	MMF	200um	P4	FC/PC	○	○
WSLX-445-020-400M-H	20W	MMF	400um	P5	FC/PC	○	○	
455nm	WSP-455-003-50M	3W	MMF	50um	Coaxial	FC/PC	×	×
	WSLX-455-003-50M-H9-T-PD	3W	MMF	50um	9-Pin	FC/PC	√	√
	WSP-455-004-200M	4W	MMF	200um	Coaxial	FC/PC	×	×
	WSLX-455-004-200M-H9-T-PD	4W	MMF	200um	9-Pin	FC/PC	√	√
465nm	WSP-465-002-M	2W	MMF	105um	Coaxial	FC/PC	×	×
	WSLX-465-002-M-H9-T-PD	2W	MMF	105um	9-Pin	FC/PC	√	√
	WSLX-465-007-200M-H	7W	MMF	200um	P4	FC/PC	○	○
	WSLX-465-015-400M-H	15W	MMF	400um	P5	FC/PC	○	○
480nm	WSP-480-050m-M	50mW	MMF	105um	Coaxial	FC/PC	×	×
	WSLX-480-050m-M-H8-T	50mW	MMF	105um	8-Pin	FC/PC	○	√
	WSP-480-080m-M	80mW	MMF	105um	Coaxial	FC/PC	×	×
	WSLX-480-080m-M-H8-T	80mW	MMF	105um	8-Pin	FC/PC	○	√
	WSLX-480-080m-M-H14-T-PD	80mW	MMF	105um	14-Pin	FC/PC	√	√
488nm	WSP-488-050m-M	50mW	MMF	105um	Coaxial	FC/PC	×	×
	WSLX-488-050m-M-H8-T	50mW	MMF	105um	8-Pin	FC/PC	○	√
	WSP-488-080m-M	80mW	MMF	105um	Coaxial	FC/PC	×	×
	WSLX-488-080m-M-H8-T	80mW	MMF	105um	8-Pin	FC/PC	○	√
	WSLX-488-080m-M-H14-T-PD	80mW	MMF	105um	14-Pin	FC/PC	√	√
495nm	WSP-495-050m-M	50mW	MMF	105um	Coaxial	FC/PC	×	×
	WSLX-495-050m-M-H8-T	50mW	MMF	105um	8-Pin	FC/PC	○	√
	WSP-495-080m-M	80mW	MMF	105um	Coaxial	FC/PC	×	×
	WSLX-495-080m-M-H8-T	80mW	MMF	105um	8-Pin	FC/PC	○	√
	WSLX-495-080m-M-H14-T-PD	80mW	MMF	105um	14-Pin	FC/PC	√	√
505nm	WSP-505-030m-M	30mW	MMF	105um	Coaxial	FC/PC	×	×
	WSLX-505-030m-M-H8-T	30mW	MMF	105um	8-Pin	FC/PC	○	√
	WSP-505-050m-M	50mW	MMF	105um	Coaxial	FC/PC	×	×
	WSLX-505-050m-M-H8-T	50mW	MMF	105um	8-Pin	FC/PC	○	√
520nm	WSP-520-010m-M-PD	10mW	MMF	105um	Coaxial	FC/PC	√	×
	WSLX-520-010m-M-H8-T-PD	10mW	MMF	105um	8-Pin	FC/PC	√	√

Note: √:Yes, ○:Optional, ×:No.

Wavelength	Part Number	Output Power	Fiber Type	Fiber Core	Package	Connector	PD	TEC
520nm	WSLP-520-030m-M-PD	30mW	MMF	105um	Coaxial	FC/PC	√	×
	WSLX-520-030m-M-H8-T-PD	30mW	MMF	105um	8-Pin	FC/PC	√	√
	WSLP-520-050m-M-PD	50mW	MMF	105um	Coaxial	FC/PC	√	×
	WSLX-520-050m-M-H8-T-PD	50mW	MMF	105um	8-Pin	FC/PC	√	√
	WSLP-520-080m-M	80mW	MMF	105um	Coaxial	FC/PC	×	×
	WSLX-520-080m-M-H8-T	80mW	MMF	105um	8-Pin	FC/PC	×	√
	WSLP-520-200m-M	200mW	MMF	105um	Coaxial	FC/PC	×	×
	WSLX-520-200m-M-H14-T-PD	200mW	MMF	105um	14-Pin	FC/PC	√	√
	WSLP-520-300m-M	300mW	MMF	105um	Coaxial	FC/PC	×	×
	WSLP-520-500m-M	500mW	MMF	105um	Coaxial	FC/PC	×	×
	WSLP-520-800m-50M	800mW	MMF	50um	Coaxial	FC/PC	×	×
	WSLX-520-800m-50M-H9-T-PD	800mW	MMF	50um	9-Pin	FC/PC	√	√
	WSLP-520-800m-M	800mW	MMF	105um	Coaxial	FC/PC	×	×
	WSLX-520-800m-M-H9-T-PD	800mW	MMF	105um	9-Pin	FC/PC	√	√
	WSLP-520-001-50M	1W	MMF	50um	Coaxial	FC/PC	×	×
	WSLX-520-001-50M-H9-T-PD	1W	MMF	50um	9-Pin	FC/PC	√	√
	WSLP-520-1200m-M	1.2W	MMF	105um	Coaxial	FC/PC	×	×
	WSLX-520-1200m-M-H9-T-PD	1.2W	MMF	105um	9-Pin	FC/PC	√	√
	WSLX-520-002-M-H	2W	MMF	105um	P4	FC/PC	○	○
	WSLX-520-005-200M-H	5W	MMF	200um	P5	FC/PC	○	○
525nm	WSLP-525-800m-50M	800mW	MMF	50um	Coaxial	FC/PC	×	×
	WSLX-525-800m-50M-H9-T-PD	800mW	MMF	50um	9-Pin	FC/PC	√	√
	WSLP-525-800m-M	800mW	MMF	105um	Coaxial	FC/PC	×	×
	WSLX-525-800m-M-H9-T-PD	800mW	MMF	105um	9-Pin	FC/PC	√	√
	WSLP-525-001-50M	1W	MMF	50um	Coaxial	FC/PC	×	×
	WSLX-525-001-50M-H9-T-PD	1W	MMF	50um	9-Pin	FC/PC	√	√
	WSLP-525-1200m-M	1.2W	MMF	105um	Coaxial	FC/PC	×	×
	WSLX-525-1200m-M-H9-T-PD	1.2W	MMF	105um	9-Pin	FC/PC	√	√
	WSLX-525-002-M-H	2W	MMF	105um	P4	FC/PC	○	○
	WSLX-525-005-200M-H	5W	MMF	200um	P5	FC/PC	○	○
532nm	WSLP-532-001-50M	1W	MMF	50um	Coaxial	FC/PC	×	×
	WSLX-532-001-50M-H9-T-PD	1W	MMF	50um	9-Pin	FC/PC	√	√
	WSLP-532-001-M	1W	MMF	105um	Coaxial	FC/PC	×	×
	WSLX-532-001-M-H9-T-PD	1W	MMF	105um	9-Pin	FC/PC	√	√
630nm	WSLX-630-300m-50M-H9-T-PD	300mW	MMF	50um	9-Pin	FC/PC	√	√
	WSLX-630-300m-M-H9-T-PD	300mW	MMF	105um	9-Pin	FC/PC	√	√
633nm	WSLX-633-700m-50M-H9-T-PD	700mW	MMF	50um	9-Pin	FC/PC	√	√
	WSLX-633-700m-M-H9-T-PD	700mW	MMF	105um	9-Pin	FC/PC	√	√

Note: √:Yes, ○:Optional, ×:No.

Wavelength	Part Number	Output Power	Fiber Type	Fiber Core	Package	Connector	PD	TEC
633nm	WSLX-633-001-200M-H9-T-PD	1W	MMF	200um	9-Pin	FC/PC	√	√
635nm	WSLP-635-005m-M-PD	5mW	MMF	105um	Coaxial	FC/PC	√	×
	WSLP-635-020m-M-PD	20mW	MMF	105um	Coaxial	FC/PC	√	×
	WSLP-635-120m-M-PD	120mW	MMF	105um	Coaxial	FC/PC	√	×
	WSLX-635-120m-M-H8-T-PD	120mW	MMF	105um	8-Pin	FC/PC	√	√
	WSLP-635-150m-M-PD	150mW	MMF	105um	Coaxial	FC/PC	√	×
	WSLX-635-150m-M-H8-T-PD	150mW	MMF	105um	8-Pin	FC/PC	√	√
	WSLP-635-300m-M	300mW	MMF	105um	Coaxial	FC/PC	×	×
	WSLX-635-300m-M-H8-T	300mW	MMF	105um	8-Pin	FC/PC	×	√
	WSLP-635-400m-M	400mW	MMF	105um	Coaxial	FC/PC	×	×
	WSLX-635-400m-M-H8-T	400mW	MMF	105um	8-Pin	FC/PC	×	√
	WSLX-635-400m-M-H4-PD	400mW	MMF	105um	4-Pin	FC/PC	√	×
	WSLX-635-400m-M-H14-T-PD	400mW	MMF	105um	14-Pin	FC/PC	√	√
	WSLP-635-800m-50M	800mW	MMF	50um	Coaxial	FC/PC	×	×
	WSLX-635-800m-50M-H9-T-PD	800mW	MMF	50um	9-Pin	FC/PC	√	√
	WSLP-635-001-M	1W	MMF	105um	Coaxial	FC/PC	×	×
	WSLX-635-001-M-H9-T-PD	1W	MMF	105um	9-Pin	FC/PC	√	√
	WSLP-635-1800m-200M	1.8W	MMF	200um	Coaxial	FC/PC	×	×
	WSLX-635-1800m-200M-H9-T-PD	1.8W	MMF	200um	9-Pin	FC/PC	√	√
645nm	WSLP-645-1800m-200M	1.8W	MMF	200um	Coaxial	FC/PC	×	×
	WSLX-645-1800m-200M-H9-T-PD	1.8W	MMF	200um	9-Pin	FC/PC	√	√
653nm	WSLX-653-700m-50M-H9-T-PD	700mW	MMF	50um	9-Pin	FC/PC	√	√
	WSLX-653-700m-M-H9-T-PD	700mW	MMF	105um	9-Pin	FC/PC	√	√
660nm	WSLP-660-030m-M-PD	30mW	MMF	105um	Coaxial	FC/PC	√	×
	WSLP-660-050m-M-PD	50mW	MMF	105um	Coaxial	FC/PC	√	×
	WSLP-660-080m-M-PD	80mW	MMF	105um	Coaxial	FC/PC	√	×
	WSLP-660-120m-M	120mW	MMF	105um	Coaxial	FC/PC	×	×
	WSLX-660-120m-M-H8-T	120mW	MMF	105um	8-Pin	FC/PC	×	√
	WSLX-660-800m-50M-H2	800mW	MMF	50um	2-Pin	FC/PC	×	×
	WSLX-660-800m-50M-H14-T-PD	800mW	MMF	50um	14-Pin	FC/PC	√	√
	WSLX-660-800m-M-H2	800mW	MMF	105um	2-Pin	FC/PC	×	×
	WSLX-660-800m-M-H14-T-PD	800mW	MMF	105um	14-Pin	FC/PC	√	√
	WSLX-660-001-50M-H2	1W	MMF	50um	2-Pin	FC/PC	×	×
	WSLX-660-001-50M-H14-T-PD	1W	MMF	50um	14-Pin	FC/PC	√	√
	WSLX-660-001-M-H2	1W	MMF	105um	2-Pin	FC/PC	×	×
	WSLX-660-001-M-H14-T-PD	1W	MMF	105um	14-Pin	FC/PC	√	√
	WSLX-660-002-M-H9-T-PD	2W	MMF	105um	9-Pin	FC/PC	√	√
	670nm	WSLP-670-005m-M-PD	5mW	MMF	105um	Coaxial	FC/PC	√

Note: √:Yes, ○:Optional, ×:No.

Wavelength	Part Number	Output Power	Fiber Type	Fiber Core	Package	Connector	PD	TEC
670nm	WSLX-670-005m-M-H8-T-PD	5mW	MMF	105um	8-Pin	FC/PC	√	√
	WSLP-670-010m-M-PD	10mW	MMF	105um	Coaxial	FC/PC	√	×
	WSLX-670-010m-M-H8-T-PD	10mW	MMF	105um	8-Pin	FC/PC	√	√
	WSLP-670-120m-M	120mW	MMF	105um	Coaxial	FC/PC	×	×
	WSLX-670-120m-M-H8-T	120mW	MMF	105um	8-Pin	FC/PC	×	√
680nm	WSLX-680-500m-M-H14-T-PD	500mW	MMF	105um	14-Pin	FC/PC	√	√
	WSLX-680-001-200M-H9-T-PD	1W	MMF	200um	9-Pin	FC/PC	√	√
685nm	WSLP-685-030m-M-PD	30mW	MMF	105um	Coaxial	FC/PC	√	×
	WSLX-685-030m-M-H8-T-PD	30mW	MMF	105um	8-Pin	FC/PC	√	√
690nm	WSLX-690-500m-M-H14-T-PD	500mW	MMF	105um	14-Pin	FC/PC	√	√
	WSLX-690-800m-M-H4	800mW	MMF	105um	4-Pin	FC/PC	○	×
	WSLX-690-800m-M-H9-T-PD	800mW	MMF	105um	9-Pin	FC/PC	√	√
	WSLX-690-1500m-200M-H9-T-PD	1.5W	MMF	200um	9-Pin	FC/PC	√	√
760nm	WSLX-760-1500m-M-H2	1.5W	MMF	105um	2-Pin	FC/PC	×	×
	WSLX-760-1500m-M-H14-T-PD	1.5W	MMF	105um	14-Pin	FC/PC	√	√
	WSLX-760-003-200M-H2	3W	MMF	200um	2-Pin	FC/PC	×	×
	WSLX-760-003-200M-H9-T-PD	3W	MMF	200um	9-Pin	FC/PC	√	√
770nm	WSLX-770-002-M-H14-T-PD	2W	MMF	105um	14-Pin	FC/PC	√	√
	WSLX-770-003-M-H2	3W	MMF	105um	2-Pin	FC/PC	×	×
	WSLX-770-003-M-H9-T-PD	3W	MMF	105um	9-Pin	FC/PC	√	√
785nm	WSLP-785-050m-M-PD	50mW	MMF	105um	Coaxial	FC/PC	√	×
	WSLX-785-050m-M-H8-T-PD	50mW	MMF	105um	8-Pin	FC/PC	√	√
	WSLX-785-1500m-50M-H2	1.5W	MMF	50um	2-Pin	FC/PC	×	×
	WSLX-785-1500m-50M-H14-T-PD	1.5W	MMF	50um	14-Pin	FC/PC	√	√
	WSLX-785-002-M-H14-T-PD	2W	MMF	105um	14-Pin	FC/PC	√	√
	WSLX-785-003-M-H2	3W	MMF	105um	2-Pin	FC/PC	×	×
	WSLX-785-003-M-H9-T-PD	3W	MMF	105um	9-Pin	FC/PC	√	√
	WSLX-785-007-M-H2	7W	MMF	105um	2-Pin	FC/PC	×	×
	WSLX-785-007-M-H9-T-PD	7W	MMF	105um	9-Pin	FC/PC	√	√
808nm	WSLP-808-150m-62M-PD	150mW	MMF	62.5um	Coaxial	FC/PC	√	×
	WSLX-808-150m-62M-H8-T-PD	150mW	MMF	62.5um	8-Pin	FC/PC	√	√
	WSLP-808-200m-M-PD	200mW	MMF	105um	Coaxial	FC/PC	√	×
	WSLX-808-200m-M-H8-T-PD	200mW	MMF	105um	8-Pin	FC/PC	√	√
	WSLP-808-300m-M-PD	300mW	MMF	105um	Coaxial	FC/PC	√	×
	WSLX-808-300m-M-H8-T-PD	300mW	MMF	105um	8-Pin	FC/PC	√	√
	WSLX-808-002-50M-H14-T-PD	2W	MMF	50um	14-Pin	FC/PC	√	√
	WSLX-808-002-M-H14-T-PD	2W	MMF	105um	14-Pin	FC/PC	√	√
	WSLX-808-004-M-H2	4W	MMF	105um	2-Pin	FC/PC	×	×

Note: √:Yes, ○:Optional, ×:No.

Wavelength	Part Number	Output Power	Fiber Type	Fiber Core	Package	Connector	PD	TEC
808nm	WSLX-808-004-M-H9-T-PD	4W	MMF	105um	9-Pin	FC/PC	√	√
	WSLX-808-005-M-H2	5W	MMF	105um	2-Pin	FC/PC	×	×
	WSLX-808-008-M-H2	8W	MMF	105um	2-Pin	FC/PC	×	×
	WSLX-808-008-M-H9-T-PD	8W	MMF	105um	9-Pin	FC/PC	√	√
	WSLX-808-010-200M-H2	10W	MMF	200um	2-Pin	FC/PC	×	×
	WSLX-808-015-M-T14	15W	MMF	105um	T14	FC/PC	×	×
	WSLX-808-025-200M-T14	25W	MMF	200um	T14	FC/PC	×	×
830nm	WSLP-830-150m-M-PD	150mW	MMF	105um	Coaxial	FC/PC	√	×
	WSLX-830-150m-M-H8-T-PD	150mW	MMF	105um	8-Pin	FC/PC	√	√
	WSLP-830-200m-M-PD	200mW	MMF	105um	Coaxial	FC/PC	√	×
	WSLX-830-200m-M-H8-T-PD	200mW	MMF	105um	8-Pin	FC/PC	√	√
	WSLX-830-001-50M-H2	1W	MMF	50um	2-Pin	FC/PC	×	×
	WSLX-830-002-50M-H2 (0.15)	2W	MMF	50um	2-Pin	FC/PC	×	×
	WSLX-830-002-50M-H14-T-PD	2W	MMF	50um	14-Pin	FC/PC	√	√
	WSLX-830-002-M-H14-T-PD	2W	MMF	105um	14-Pin	FC/PC	√	√
	WSLX-830-003-M-H2	3W	MMF	105um	2-Pin	FC/PC	×	×
850nm	WSLP-850-050m-M-PD	50mW	MMF	105um	Coaxial	FC/PC	√	×
	WSLX-850-050m-M-H8-T-PD	50mW	MMF	105um	8-Pin	FC/PC	√	√
	WSLP-850-150m-M-PD	150mW	MMF	105um	Coaxial	FC/PC	√	×
	WSLX-850-150m-M-H8-T-PD	150mW	MMF	105um	8-Pin	FC/PC	√	√
	WSLP-850-200m-M-PD	200mW	MMF	105um	Coaxial	FC/PC	√	×
	WSLX-850-200m-M-H8-T-PD	200mW	MMF	105um	8-Pin	FC/PC	√	√
880nm	WSLP-880-005m-M-PD	5mW	MMF	105um	Coaxial	FC/PC	√	×
	WSLX-880-005m-M-H8-T-PD	5mW	MMF	105um	8-Pin	FC/PC	√	√
	WSLX-880-002-M-H14-T-PD	2W	MMF	105um	14-Pin	FC/PC	√	√
	WSLX-880-003-M-H2	3W	MMF	105um	2-Pin	FC/PC	×	×
905nm	WSLP-905-120m-M-PD	120mW	MMF	105um	Coaxial	FC/PC	√	×
	WSLX-905-120m-M-H8-T-PD	120mW	MMF	105um	8-Pin	FC/PC	√	√
	WSLP-905-150m-M-PD	150mW	MMF	105um	Coaxial	FC/PC	√	×
	WSLX-905-150m-M-H8-T-PD	150mW	MMF	105um	8-Pin	FC/PC	√	√
915nm	WSLX-915-002-M-H14-T-PD	2W	MMF	105um	14-Pin	FC/PC	√	√
	WSLX-915-010-M-H2	10W	MMF	105um	2-Pin	FC/PC	×	×
	WSLX-915-010-M-H9-T-PD	10W	MMF	105um	9-Pin	FC/PC	√	√
	WSLX-915-020-M-T14	20W	MMF	105um	T14	FC/PC	×	×
	WSLX-915-030-M-T14	30W	MMF	105um	T14	FC/PC	×	×
	WSLX-915-055-M-T13	55W	MMF	105um	T13	FC/PC	×	×
940nm	WSLP-940-200m-M-PD	200mW	MMF	105um	Coaxial	FC/PC	√	×
	WSLX-940-200m-M-H8-T-PD	200mW	MMF	105um	8-Pin	FC/PC	√	√

Note: √:Yes, ○:Optional, ×:No.

Wavelength	Part Number	Output Power	Fiber Type	Fiber Core	Package	Connector	PD	TEC
940nm	WSLX-940-002-M-H14-T-PD	2W	MMF	105um	14-Pin	FC/PC	√	√
	WSLX-940-010-M-H2	10W	MMF	105um	2-Pin	FC/PC	×	×
	WSLX-940-010-M-H9-T-PD	10W	MMF	105um	9-Pin	FC/PC	√	√
	WSLX-940-020-M-T14	20W	MMF	105um	T14	FC/PC	×	×
	WSLX-940-030-M-T14	30W	MMF	105um	T14	FC/PC	×	×
	WSLX-940-055-M-T13	55W	MMF	105um	T13	FC/PC	×	×
980nm	WSLP-980-100m-M-PD	100mw	MMF	105um	Coaxial	FC/PC	√	×
	WSLX-980-100m-M-H8-T-PD	100mW	MMF	105um	8-Pin	FC/PC	√	√
	WSLP-980-150m-M-PD	150mw	MMF	105um	Coaxial	FC/PC	√	×
	WSLX-980-150m-M-H8-T-PD	150mW	MMF	105um	8-Pin	FC/PC	√	√
	WSLX-980-002-M-H14-T-PD	2W	MMF	105um	14-Pin	FC/PC	√	√
	WSLX-980-010-M-H2	10W	MMF	105um	2-Pin	FC/PC	×	×
	WSLX-980-010-M-H9-T-PD	10W	MMF	105um	9-Pin	FC/PC	√	√
	WSLX-980-020-M-T14	20W	MMF	105um	T14	FC/PC	×	×
	WSLX-980-030-M-T14	30W	MMF	105um	T14	FC/PC	×	×
	WSLX-980-055-M-T13	55W	MMF	105um	T13	FC/PC	×	×
1064nm	WSLX-1064-001-M-H14-T-PD	1W	MMF	105um	14-Pin	FC/PC	√	√
	WSLX-1064-008-M-H2	8W	MMF	105um	2-Pin	FC/PC	×	×
	WSLX-1064-008-M-H9-T-PD	8W	MMF	105um	9-Pin	FC/PC	√	√
	WSLX-1064-025-M-HH2	25W	MMF	105um	2-Pin	FC/PC	×	×
1310nm	WSLX-1310-001-M-H2	1W	MMF	105um	2-Pin	FC/PC	×	×
	WSLX-1310-001-M-H14-T-PD	1W	MMF	105um	14-Pin	FC/PC	√	√
1330nm	WSLX-1330-001-M-H2	1W	MMF	105um	2-Pin	FC/PC	×	×
	WSLX-1330-001-M-H14-T-PD	1W	MMF	105um	14-Pin	FC/PC	√	√
1450nm	WSLX-1450-500m-M-H14-T-PD	500mW	MMF	105um	14-Pin	FC/PC	√	√
	WSLX-1450-002-M-H2	2W	MMF	105um	2-Pin	FC/PC	×	×
	WSLX-1450-002-M-H9-T-PD	2W	MMF	105um	9-Pin	FC/PC	√	√
1470nm	WSLX-1470-800m-M-H14-T-PD	800mW	MMF	105um	14-Pin	FC/PC	√	√
	WSLX-1470-001-M-H2	1W	MMF	105um	2-Pin	FC/PC	×	×
	WSLX-1470-2500m-M-H2	2.5W	MMF	105um	2-Pin	FC/PC	×	×
	WSLX-1470-2500m-M-H9-T-PD	2.5W	MMF	105um	9-Pin	FC/PC	√	√
	WSLX-1470-003-M-H2	3W	MMF	105um	2-Pin	FC/PC	×	×
	WSLX-1470-003-M-H9-T-PD	3W	MMF	105um	9-Pin	FC/PC	√	√
1490nm	WSLX-1490-500m-M-H14-T-PD	500mW	MMF	105um	14-Pin	FC/PC	√	√
	WSLX-1490-003-M-H2	3W	MMF	105um	2-Pin	FC/PC	×	×
	WSLX-1490-003-M-H9-T-PD	3W	MMF	105um	9-Pin	FC/PC	√	√
1530nm	WSLX-1530-500m-M-H14-T-PD	500mW	MMF	105um	14-Pin	FC/PC	√	√
	WSLX-1530-002-M-H2	2W	MMF	105um	2-Pin	FC/PC	×	×

Note: √:Yes, ○:Optional, ×:No.

Wavelength	Part Number	Output Power	Fiber Type	Fiber Core	Package	Connector	PD	TEC
1530nm	WSLX-1530-002-M-H9-T-PD	2W	MMF	105um	9-Pin	FC/PC	√	√
1550nm	WSLX-1550-500m-M-H14-T-PD	500mW	MMF	105um	14-Pin	FC/PC	√	√
	WSLX-1550-1500m-M-H2	1.5W	MMF	105um	2-Pin	FC/PC	×	×
	WSLX-1550-1500m-M-H9-T-PD	1.5W	MMF	105um	9-Pin	FC/PC	√	√
	WSLX-1550-2500m-M-H2	2.5W	MMF	105um	2-Pin	FC/PC	×	×
	WSLX-1550-2500m-M-H9-T-PD	2.5W	MMF	105um	9-Pin	FC/PC	√	√
1570nm	WSLX-1570-500m-M-H14-T-PD	500mW	MMF	105um	14-Pin	FC/PC	√	√
	WSLX-1570-2500m-M-H2	2.5W	MMF	105um	2-Pin	FC/PC	×	×
	WSLX-1570-2500m-M-H9-T-PD	2.5W	MMF	105um	9-Pin	FC/PC	√	√
1920nm	WSLX-1920-400m-M-H2	400mW	MMF	105um	2-Pin	FC/PC	×	×

Note: √:Yes, ○:Optional, ×:No.

Coaxial Package View:

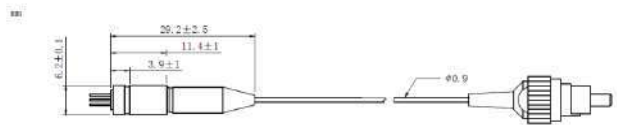

B8 Package View (with heat-sink) :

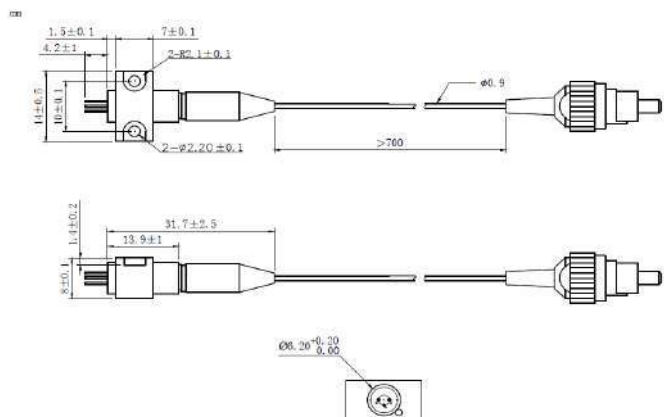

2-Pin Package View :

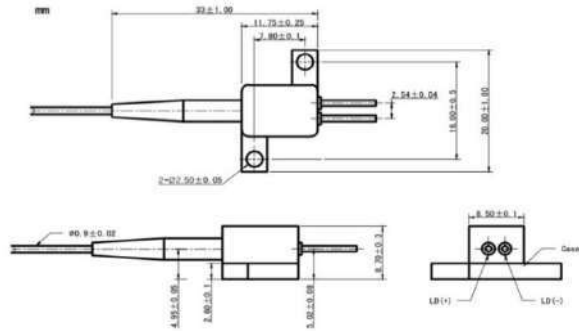

4-Pin Package View :

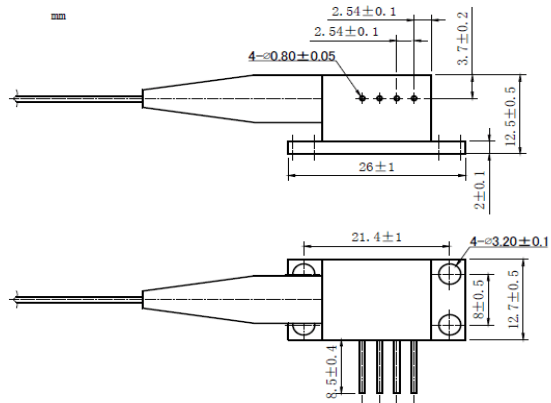

9-Pin Package View :

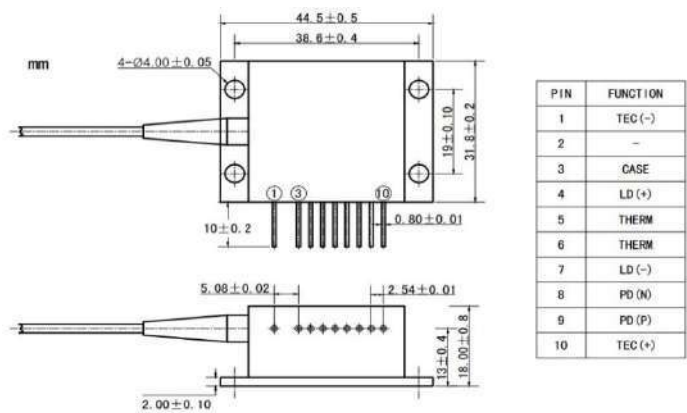
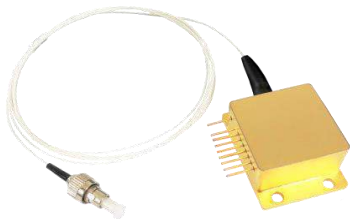

14-Pin Package View :

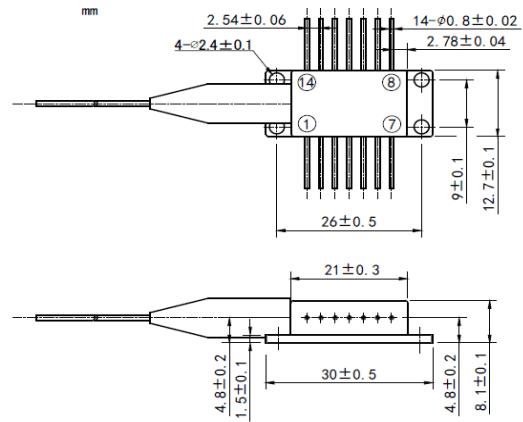
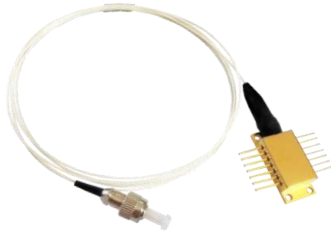

P4 Package View :

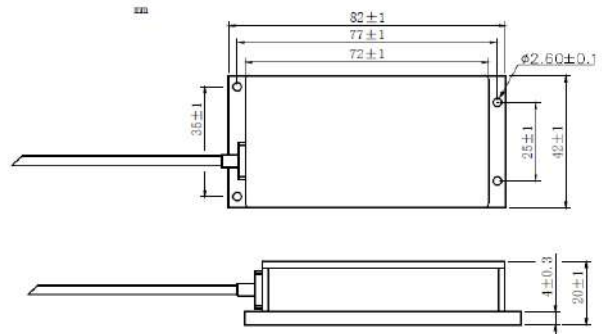

P5 Package View :

